

KriegerSCIF Sound Group 4 Wood Veneer Door



Model: SCIF-WV-SG4



Sound Group 4
SCIF Standard

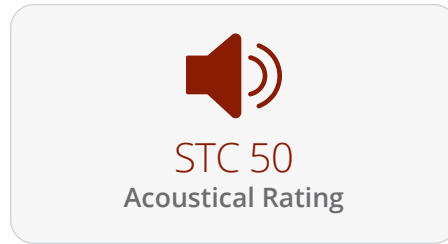

STC 50
Acoustical Rating



KriegerSCIF doors are engineered to comply with ICD 705 for sensitive compartmented information facilities (SCIFs). This innovative SCIF assembly with a wood veneer finish meets Sound Group 4 requirements and features an STC 50 acoustical rating.

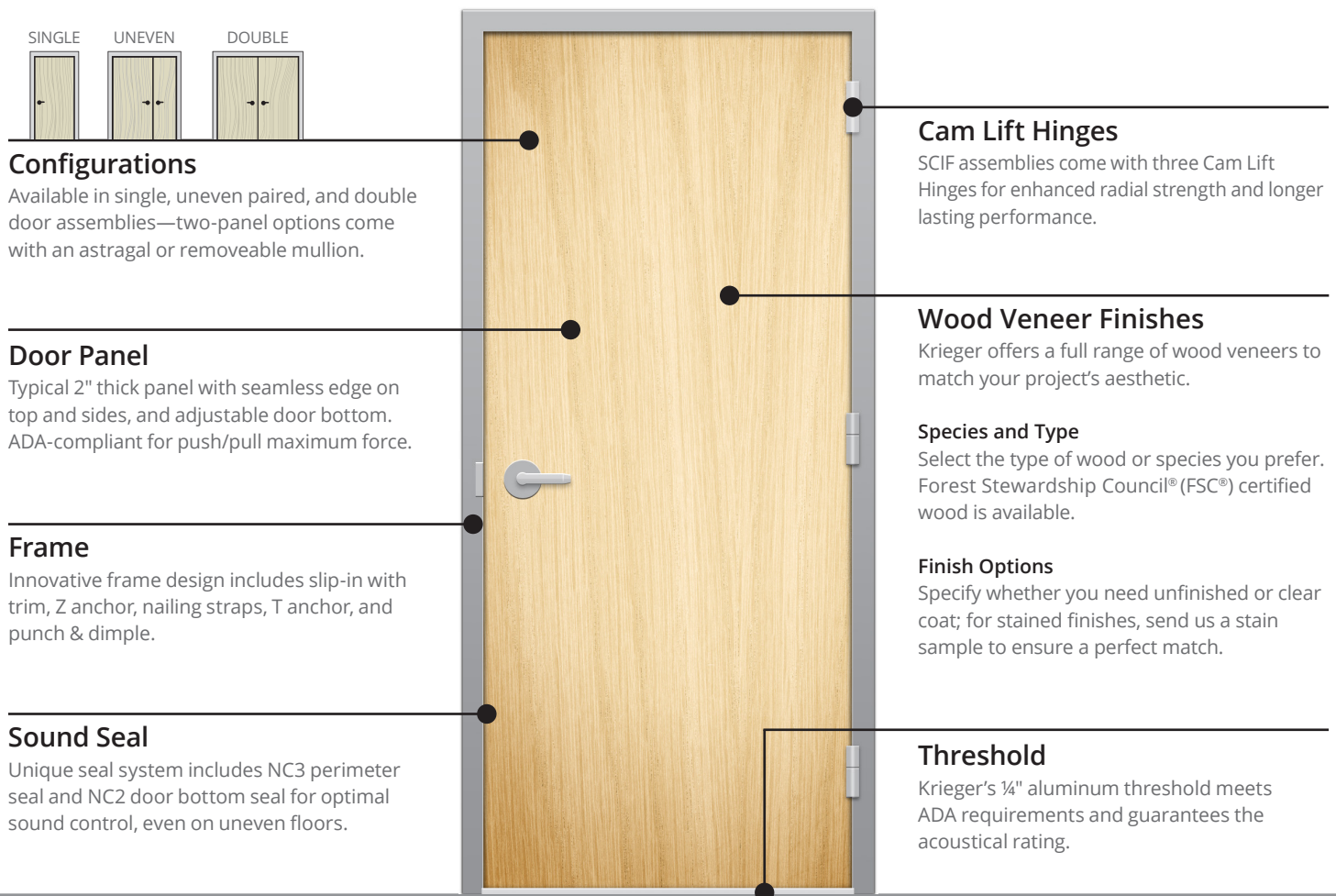

HM-00013 Feb 2026

Customize Your Assembly

Contact your Krieger Regional Sales Manager to discuss your project requirements, get a quote, and request full test report data.

Call us at 877.671.7011 or visit KriegerProducts.com to get started.





Tests and Certifications

- Complies with ICD 705 Sound Group 4 requirements for SCIFs.
- Successfully tested and rated to STC 50 (NIC 45 in situ); higher ratings up to STC 55 are available.
- Can be configured with a built-in UL 752 bullet rating up to Level 3; higher bullet ratings are available up to Level 10.
- Tested to: ASTM E90, ASTM E336, ASTM E1408, ASTM E413, ASTM A 1008, JUIAF, JAFAN, DCID 6/9, and ICPM 2006-700-7.

Door and Frame Construction

- Choice of frame design includes: slip-in with trim, Z anchor, nailing straps, T anchor, and punch & dimple.
- Unique compression sound seal system includes Krieger's NC3 perimeter seal and NC2 door bottom seal.
- NC2 semi-mortised door bottom adjustability ensures optimal performance, even on uneven floors.
- Features 2" thick door panel and can meet all specifications for size, finish, and performance; contact us to customize your assembly.
- Door panel meets ADA requirements for push/pull maximum force.
- Comes with an ADA-compliant ¼" aluminum threshold.

Fire Labels and Positive Pressure

- **Up to 60 Minutes:** UL 10C, UBC 7-2, UBC 7-4, 250°, 450°, 650° temperature rise up to 10'0" x 9'10" opening size
- **Smoke Labels:** Up to 20 minutes

Door Sizes

- SCIF doors are available in standard and custom sizes, including oversized doors.

Hardware

- SCIF assemblies come with three HC30 Cam Lift Hinges: two support hinges and one electrified hinge.
- Designed to interface with recommended builder's hardware, including latches and locksets, panic devices, security hardware, access controls, and other options.
- Option to come installed with a Sargent & Greenleaf or Lockmasters 2890 locking device.

Wood Veneer Finishes

- Krieger offers a full range of custom wood veneers to perfectly complement your project.
- Select the wood species or type of wood veneer, and whether you need unfinished or clear coat finish.
- If you need a stained finish, send us a stain sample to ensure a perfect match.
- Forest Stewardship Council® (FSC®) certified wood is available.

705 SCIF Door and Lock Package

Door & Lock All in One Box

DOOR AND SLIP-IN FRAME

- 100% ICD 705 Certified
- SCIF Sound Groups 3 or 4
- Fully ADA Compliant

CHOICE OF LOCKING DEVICE

- Sargent & Greenleaf
- Lockmasters

NEW!
Option to Add Radio
Frequency 40 dB Protection
(TEMPEST)





Elevation View

Single Door

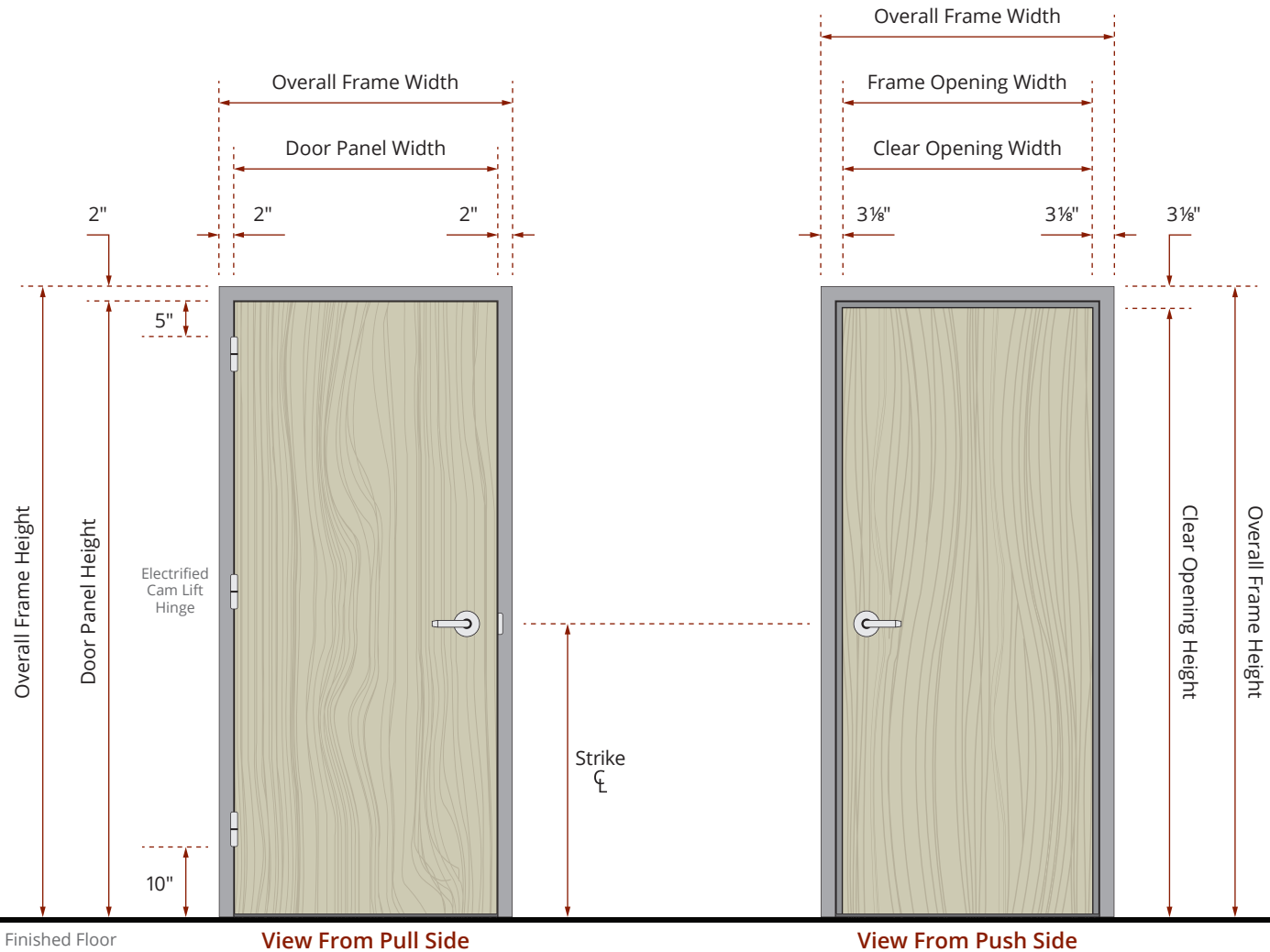

Door Handing Options

KriegerSCIF doors are available in any door handing configuration your project requires.

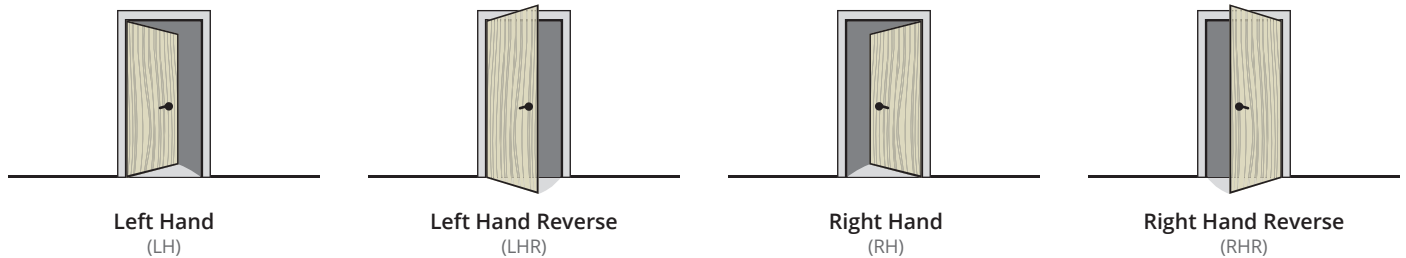



Elevation View

Double Door With Mullion

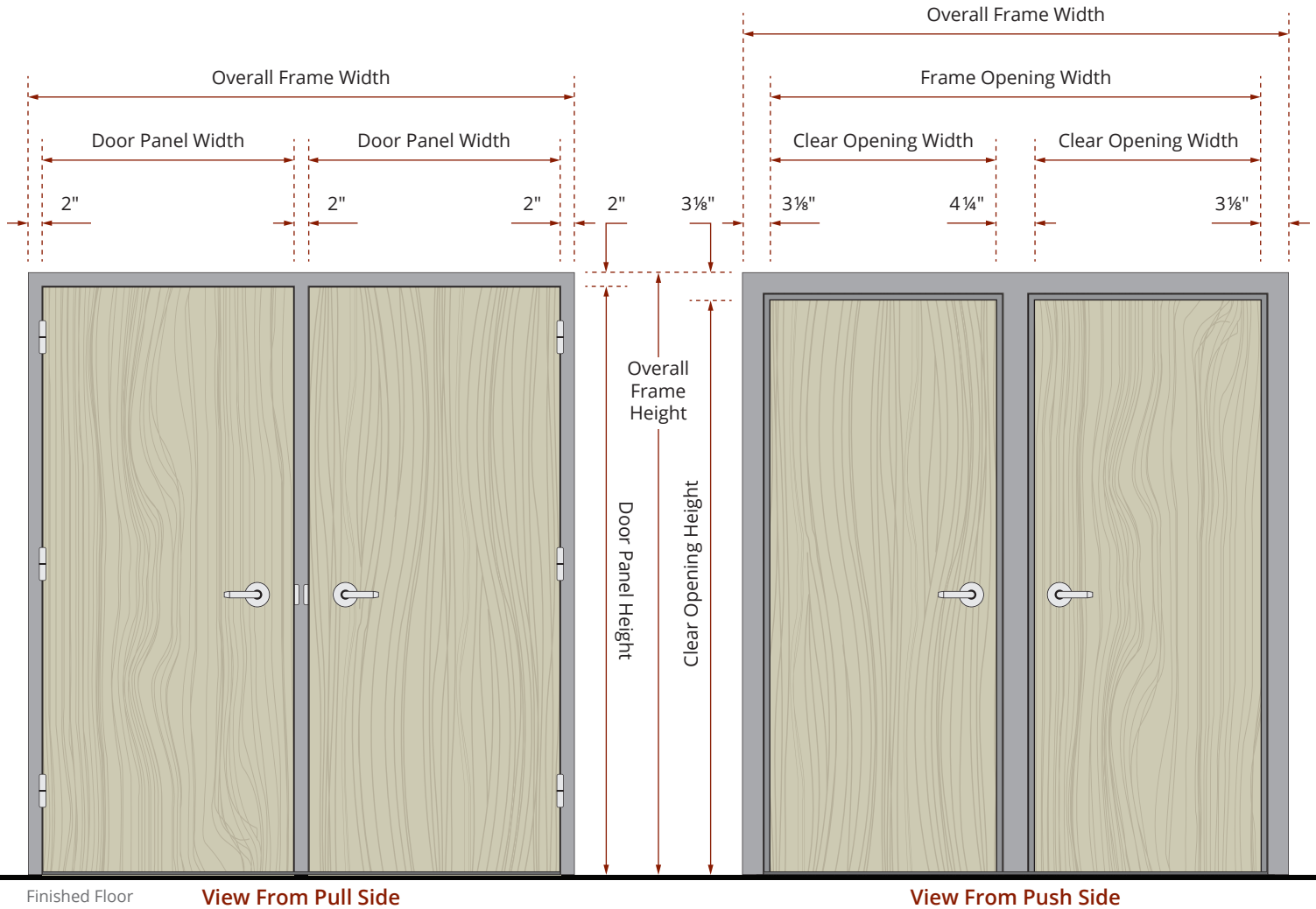

Finished Floor

View From Pull Side

View From Push Side

Door Handing Options

KriegerSCIF doors are available in any door handing configuration your project requires. SCIF double doors come with an astragal per the ICD 705 standard; mullion is available upon request.

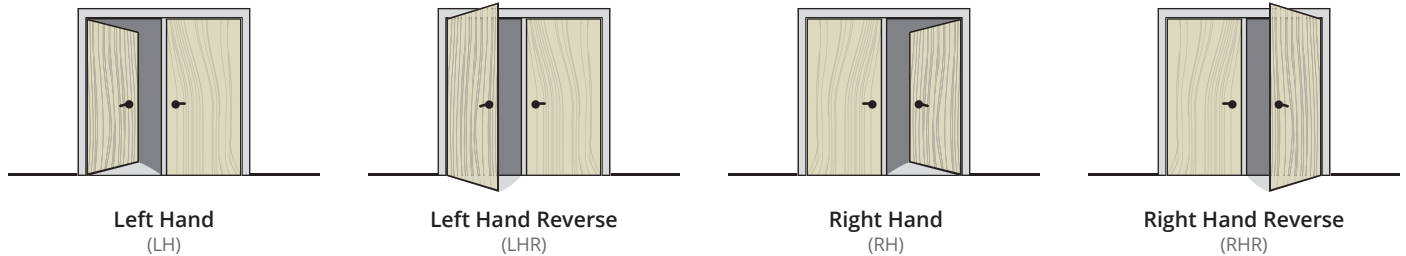



Elevation View

Double Door With Astragal

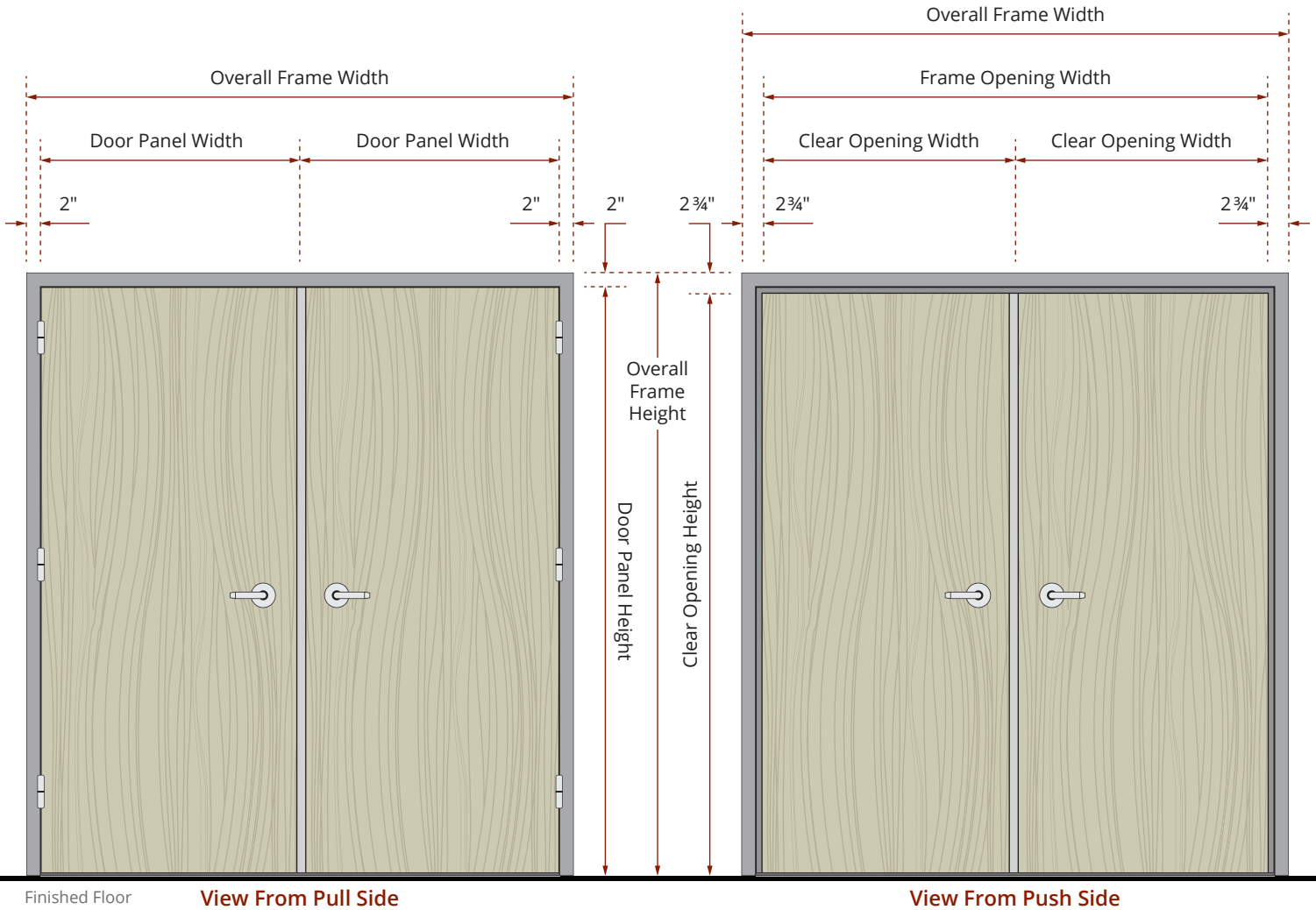

Finished Floor

View From Pull Side

View From Push Side

Door Handing Options

KriegerSCIF doors are available in any door handing configuration your project requires. SCIF double doors come with an astragal per the ICD 705 standard; mullion is available upon request.

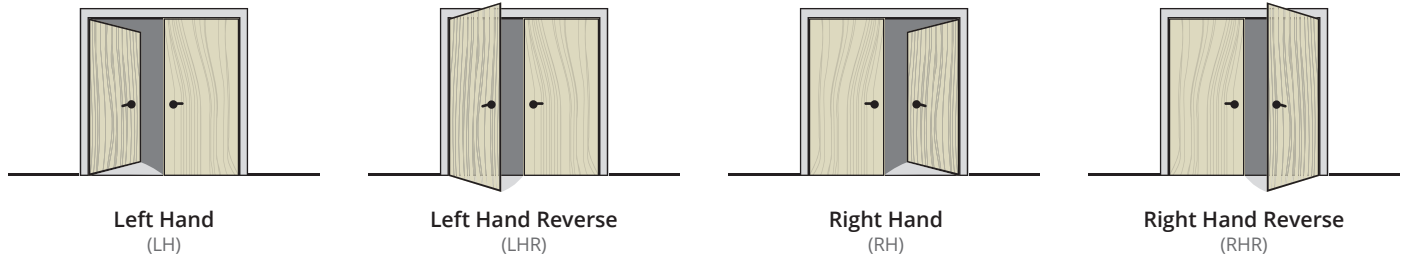



Frame Detail

Slip-In With Trim Frame

Z anchor, nailing straps, T anchor, and punch & dimple frames are also available.

Door Panel

Comes with a typical 2" thick door panel with a seamless edge on the top and sides, and an adjustable door bottom.

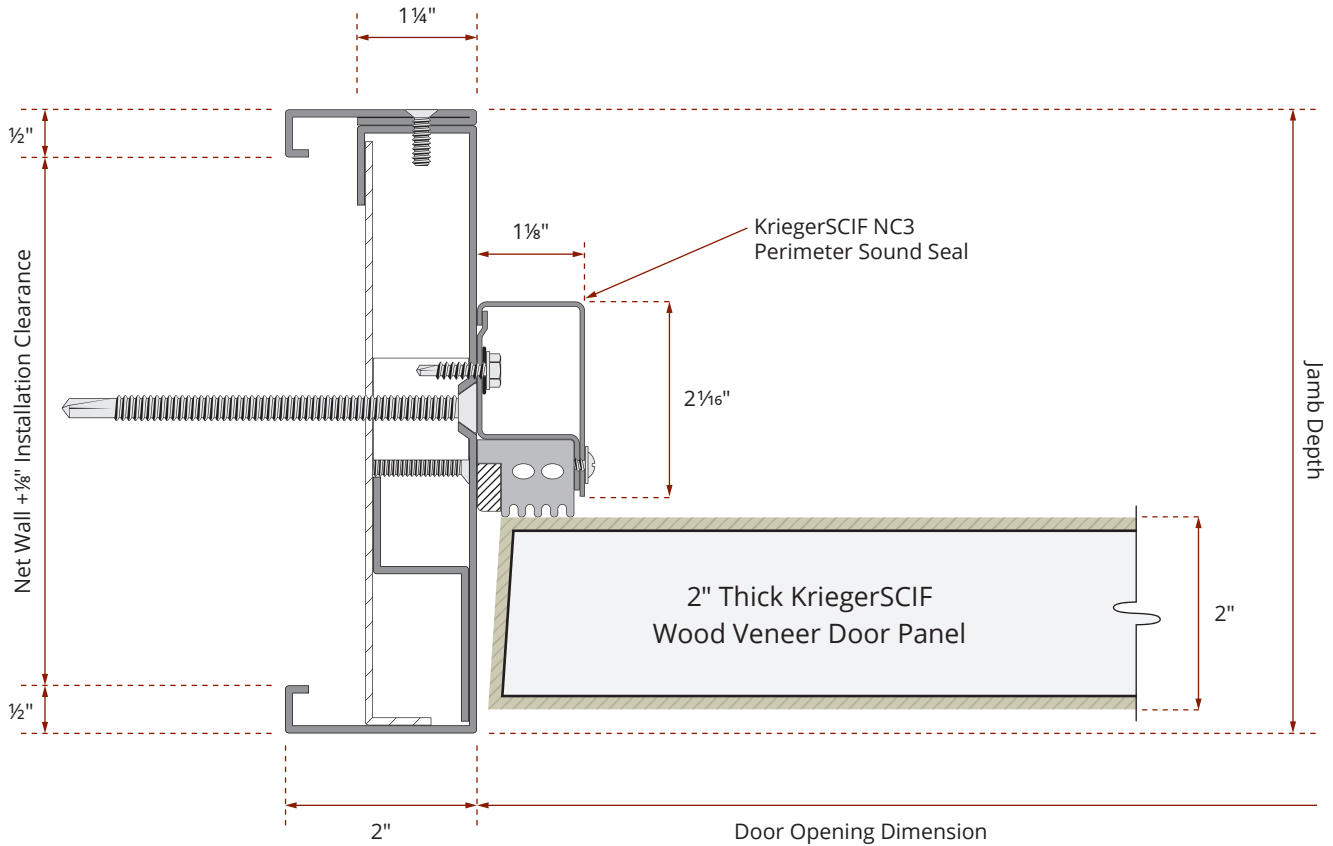



Frame Detail

Mullion Detail

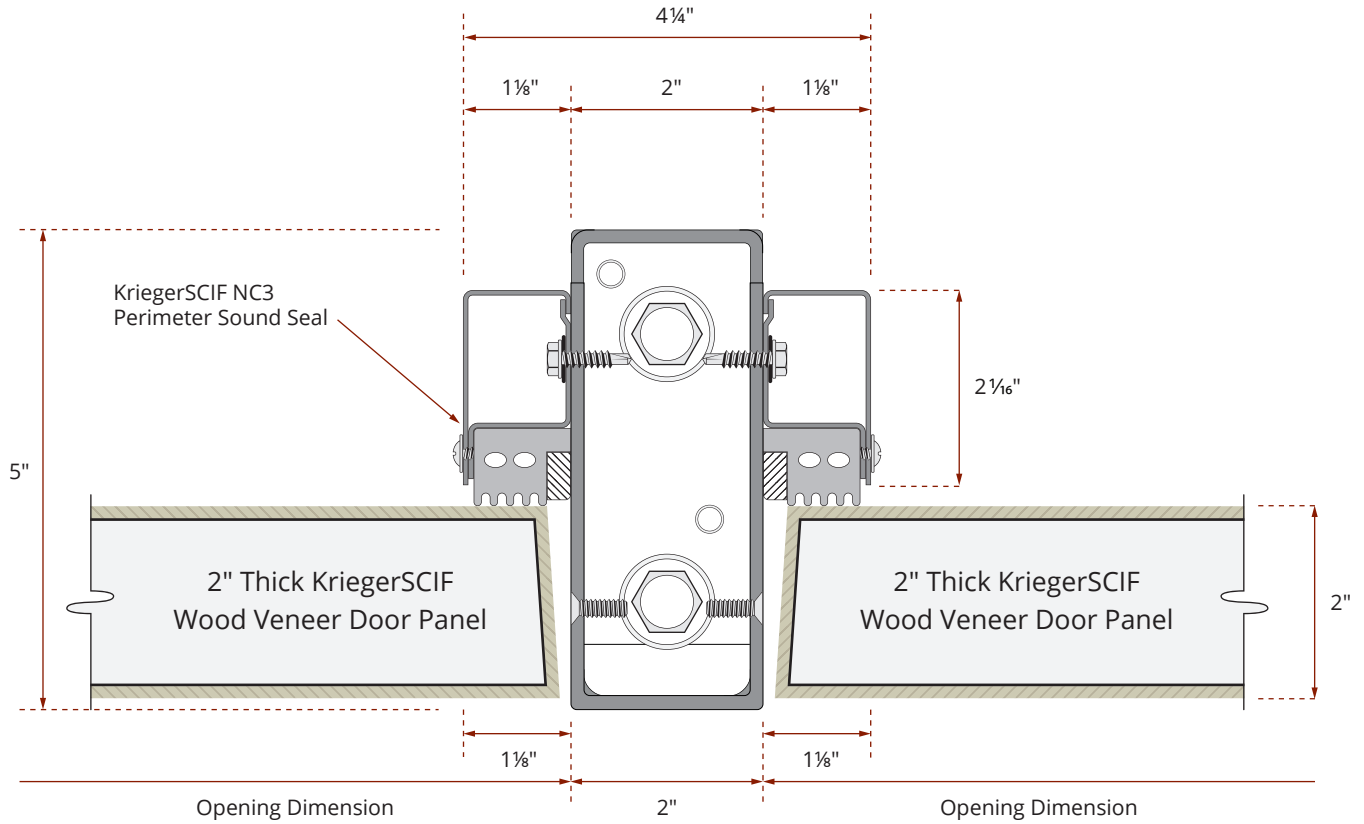



Frame Detail

Astragal Detail

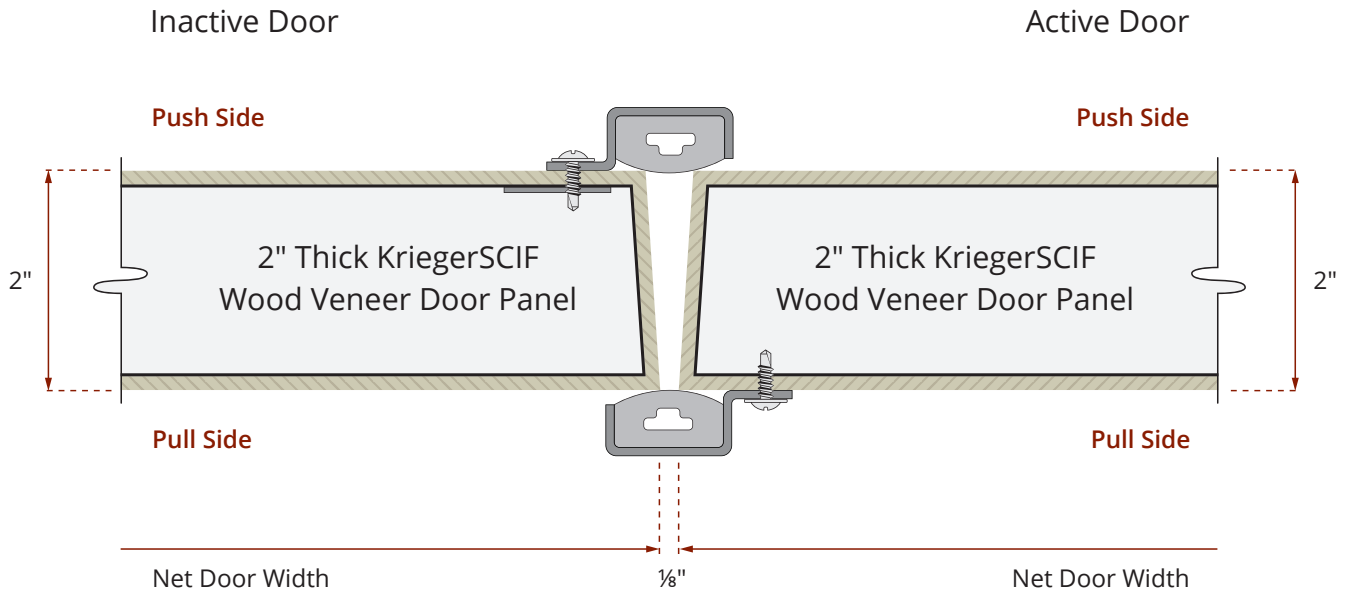



Door Bottom

Adjustable Door Bottom Detail

